

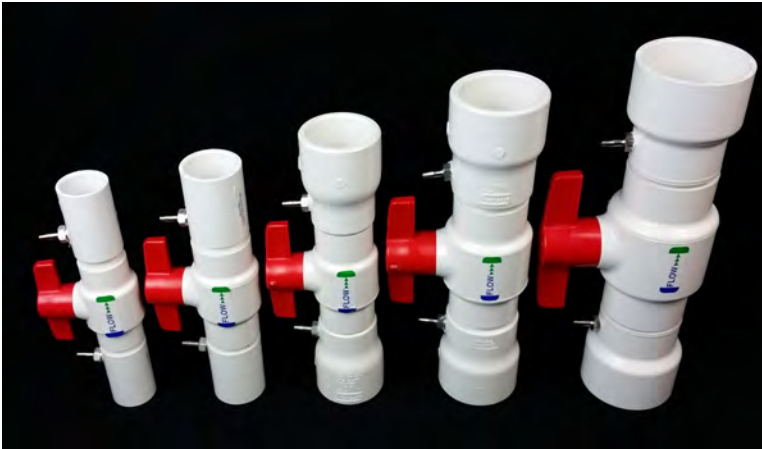

*A Green Solutions Company™*

## INSTALLATION AND OPERATING GUIDE Coupling Ball Valve



For an overview of the EZ-FLO System  
Installation & operation:

[www.ezfloinjection.com/videos/](http://www.ezfloinjection.com/videos/)

**\* IMPORTANT \***

**READ INSTRUCTIONS BEFORE INSTALLING THE SYSTEM  
TO INSURE PROPER INSTALLATION**

**EZ-FLO Injection Systems  
Sold Separately**

- Do not connect to an irrigation system that is not protected by an approved back flow prevention device.
- Do not install if pressure exceeds 80 PSI
- Use only with non-hazardous products
- Minimize exposure to direct sunlight to maximize service life
- Protect against freezing to avoid fracture

# System Installation

## Typical installation

The system is normally installed in a valve box, connected to the main line of the irrigation system after the back flow preventer and before the sprinkler valves. One unit will feed both drip and sprinkler zones without changing any connections or nozzles. It will feed both the front and back yard landscapes.

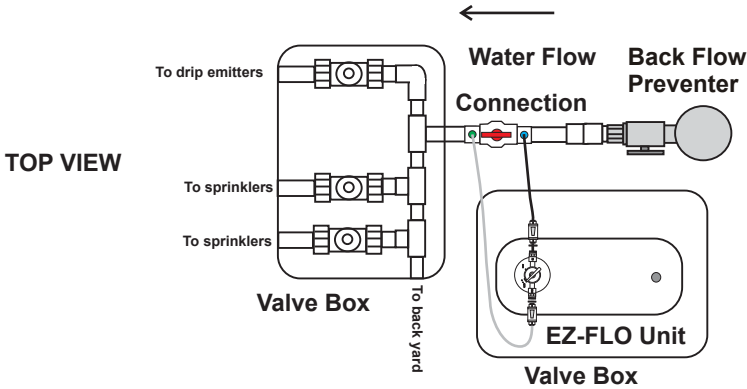

## Step 1 - Locate the installation point.

Connection must be made after an approved back flow prevention device. The connection can be made either vertically or horizontally in the irrigation main line. A "CBV" style connection is required.

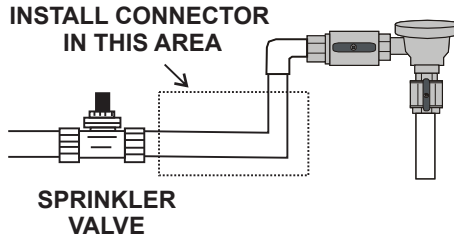

## Step 2 - Shut off water and relieve pressure

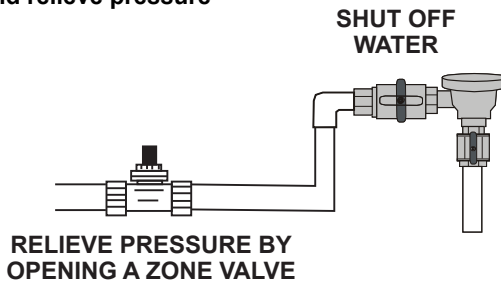

# Main Line Connection (Sold separately)

**Step 3 - Cut out a section of pipe** slightly larger than the cut out length of the coupling.

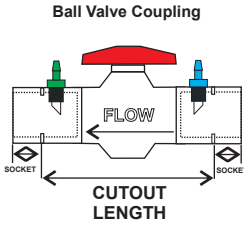

**GLUE IN COUPLING WITH FLOW ARROW POINTING IN THE DIRECTION OF THE WATER FLOW**

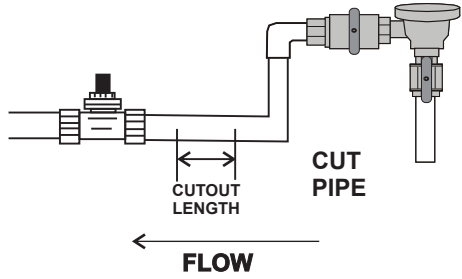

**Step 4 - Glue the coupling** into the line.

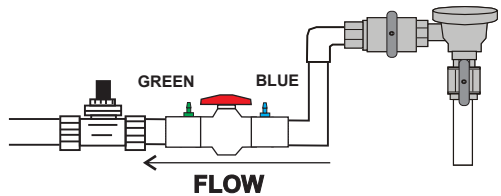

**Step 5 - Attach tubing** to the coupling.

**ATTACH BLACK TUBING TO BLUE FITTING, CLEAR TUBING TO GREEN FITTING AND SECURE WITH TUBING CLAMPS**

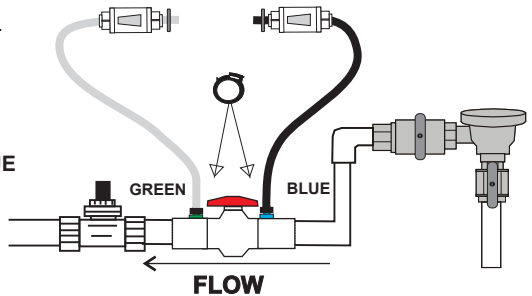

\*Calibrating the CBV connection is on subsequent pages

# Connector Calibration - Coupling Ball Valve

The CBV connection must be calibrated to the flow rate of your irrigation system. If the irrigation system is higher flow, primarily composed of spray heads or larger drip irrigation zones, adjustment to the CBV may not be required.

The EZ-FLO system must be full of fertilizer which provides a color that can be used to indicate flow through the clear line. If your fertilizer is not colored, add blue or green dye to the tank.

Start by setting the proportioning cap adjustment setting to the fast position and the CBV in full open position.

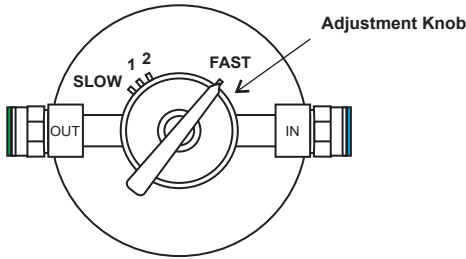

**PROPORTIONING CAP**

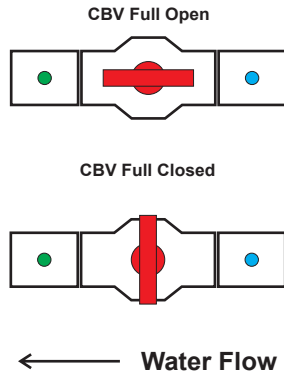

**Step 9** - Turn on a sprinkler or drip zone with the closest to average gallons per minute flow rate and watch the clear fertilizer out tubing for color

If color is steadily flowing through the clear output tube, the CBV does not require adjustment. **Please note the color in the tube will be lighter than the color in the tank due to the mixing**

If color is not flowing, slowly turn the CBV to the closed position in small increments, stopping once color begins to flow.

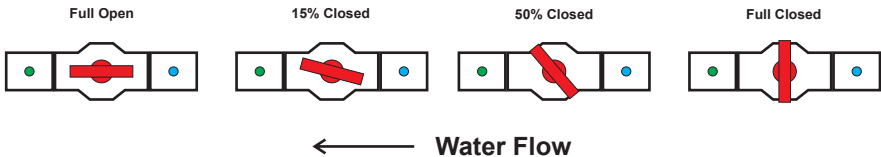

Once color is visible, you no longer have to adjust the CBV connection. You may leave it in position permanently. **Full closed is not common and may indicate improper installation or filling of the system.**

Set the Proportioning Cap feed rate to the desired level. **Please note, color will be lighter on the slower feed rate settings.**

**Adjusting the ball valve will not affect the performance of the irrigation system.** The valve closure is only necessary when the irrigation system is not operating at full capacity. Water is diverted through the EZ-FLO system as a bypass and reintroduced downstream of the valve eliminating the pressure and flow loss.