

INSTALLATION AND OPERATING GUIDE HIGH CAPACITY SYSTEMS



MODELS: EZ010-HC, EZ017-HC, EZ025-HC
(EZ025-HC PICTURED)

For an overview of the EZ-FLO System
Installation & operation:

www.ezfloinjection.com/videos/

*** IMPORTANT ***

***READ INSTRUCTIONS BEFORE INSTALLING THE SYSTEM
TO INSURE PROPER INSTALLATION***

- Do not connect to an irrigation system that is not protected by an approved back flow prevention device
- Use only with non-hazardous products
- Minimize exposure to direct sunlight to maximize service life
- Do not install if water hammer is present
- Do not install if pressure exceeds 80 PSI

HC TANK ASSEMBLY & PARTS LIST

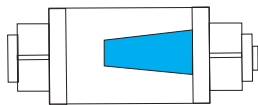
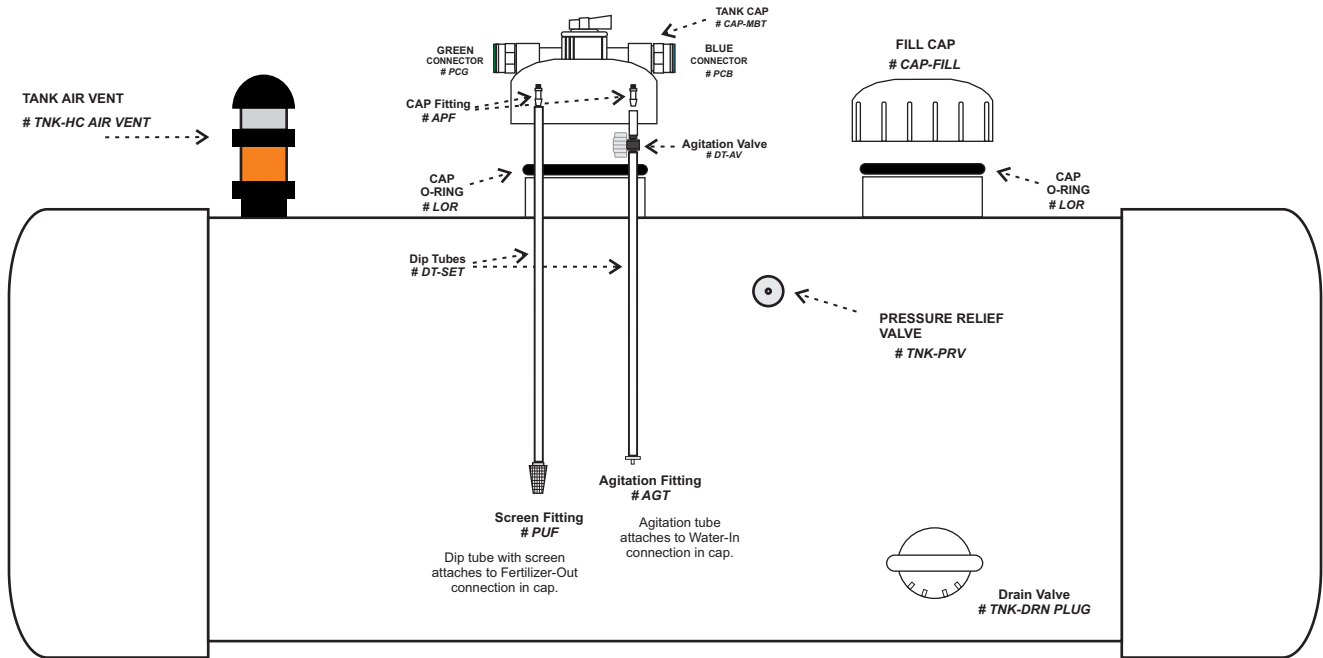

2 - Shut Off Valves
Part # SOV (with 2 washers)



3 - Tubing Clamps
Part # RTC (1 Extra)

5- Feet 1/4" Black Tubing
Part # BT5

5- Feet 1/4" Clear Tubing
Part # CT5

For EZ-FLO Warranty information visit our website at: www.ezfloinjection.com

CAP Tubing Fittings: Insert & Release

Top View

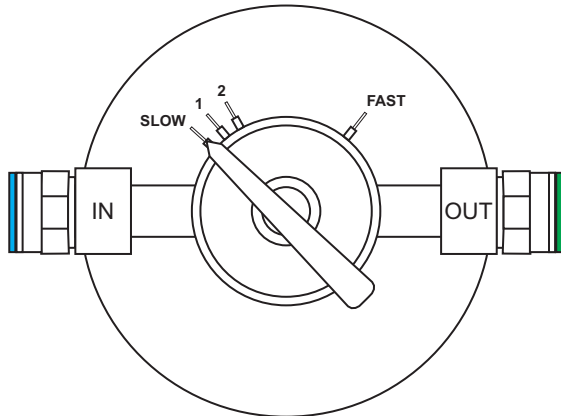

Side View

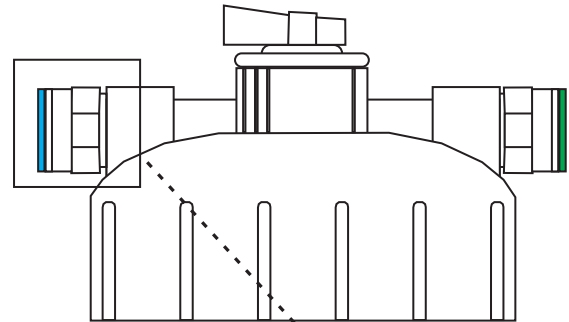

The EZ-FLO system uses push connect fittings to connect the clear and black 1/4" tubing to the cap.

To Insert:

Step 1. Insert the end of the tubing into the appropriate side (Clear to Green/Out and Black to Blue/In) by pressing into the hole/Collet. Press gently until the tubing stops.

Step 2. Gently tug the tubing to insure it is locked into place.

To Remove:

Step 1. Shut off pressure to the system.

Step 2. Apply gentle pressure to the Green or Blue Collet with your fingers.

Step 3. While holding pressure, gently pull the tubing away from the fitting to release.

Note: Make sure to direct the fitting away from your face and body. A small amount of residual pressure may be in the tank and cause a momentary release of fluid.

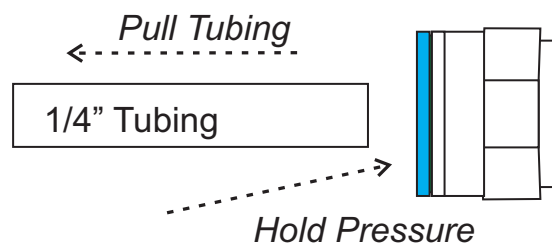
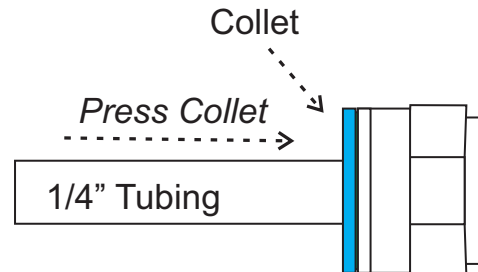
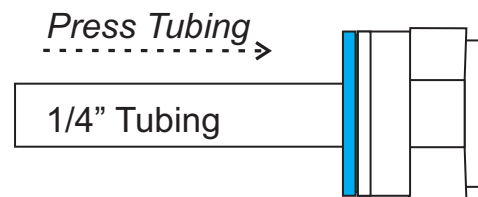

System Installation

Typical installation

The EZ-FLO Mainline Injection Systems are normally installed in a valve box, connected to the main line of the irrigation system after the back flow preventer. This will allow the system to inject to any irrigation zone valve located after the installation point. **One unit will feed both drip and sprinkler zones automatically adjusting for pressure and flow.**

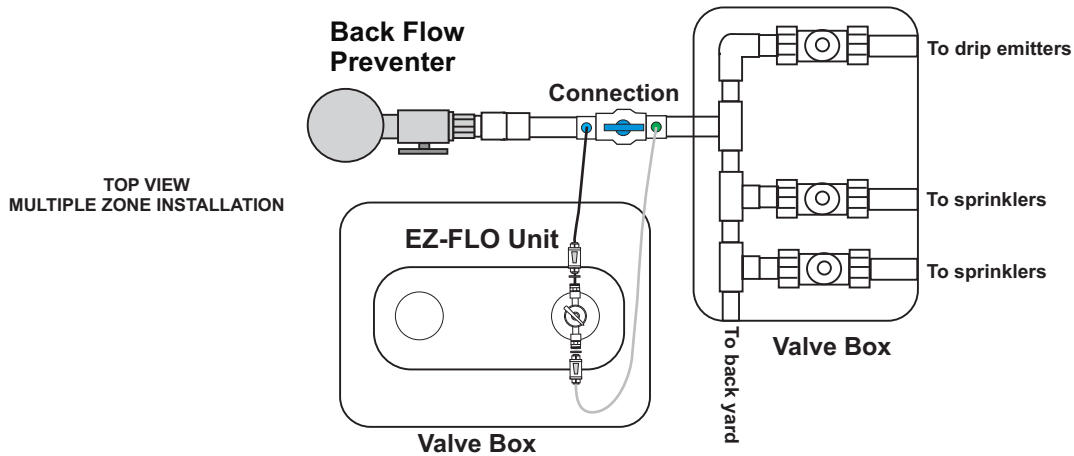

Step 1 - Locate the installation point and pipe size

- Connection must be made after an approved back flow prevention device.*
- The connection can be made either **vertically or horizontally** in the irrigation main line.
- The connection may be installed **above or below** the tank without issue.
- The connection may be **any distance** from the back flow prevention device.
- Multi-zone installation feeds all irrigations zones
- Single zone feeds only one zone

Use only the correct size connection for the installation as indicated on the CBV box label.

Part#	Mainline Size
CBV-100	3/4" & 1"
CBV-125	1.25"
CBV-150	1.5"
CBV-200	2"
CBV-250	2.5"
CBV-300	3"
CBV-400	4"

Saddle kits & C-Spools available for larger main line connections.

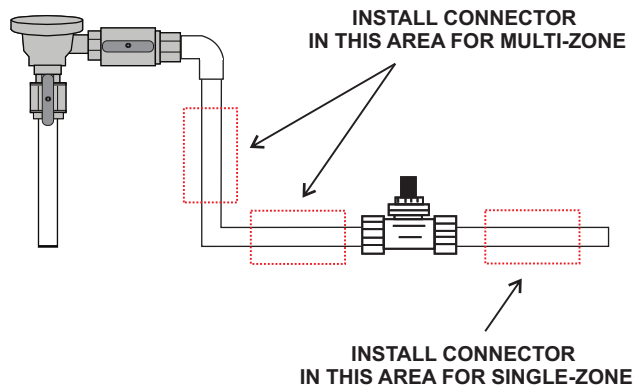

Do not use reducing bushings on the CBV unless directed to by an EZ-FLO representative (does not apply to CBV-100).

If your irrigation mainline has multiple diameters, such as a pump discharge to a larger mainline, it is best to install in the smallest diameter available to obtain best performance.

*Installations on a mainline may only be used with a mainline rated system. Installations after a zone valve or on a well may not be subject to the same back flow requirements.

Main Line Connection

Step 2 - Shut of water and relieve pressure

You can use the valve on the back flow prevention device (pictured) or shut off your water main.

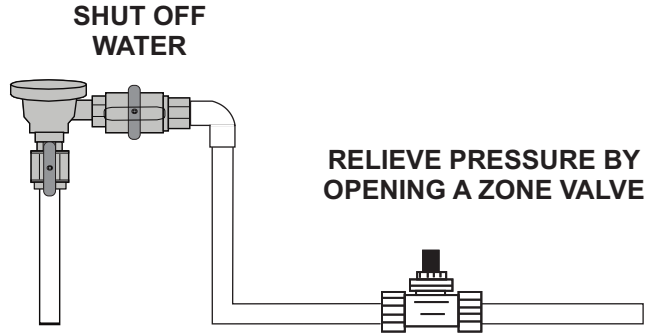

Step 3 - Cut out a section of pipe slightly larger than the cut out length of the coupling.

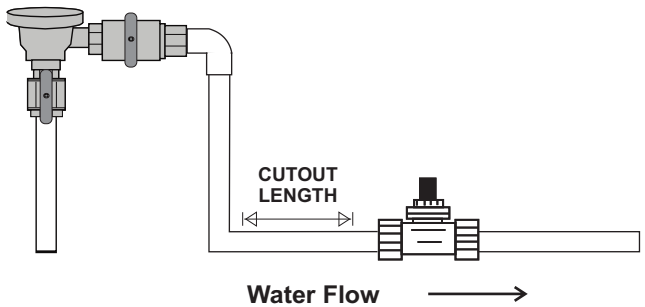
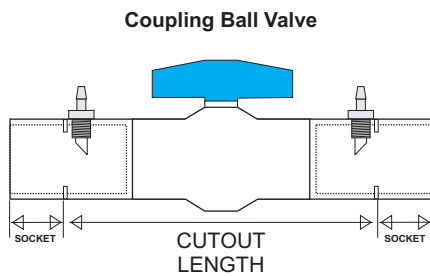

Step 4 - Glue the coupling into the line.

CBV-100 ONLY
USE INCLUDED REDUCING BUSHINGS FOR 3/4" PVC INSTALLATION

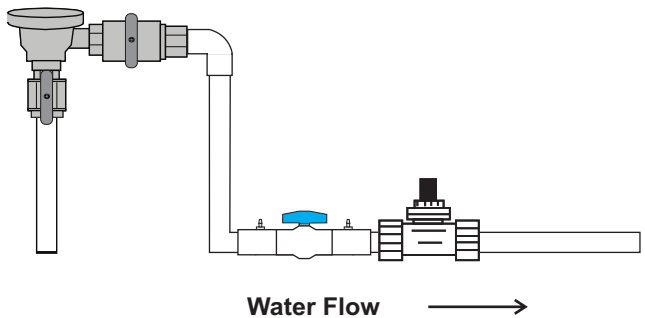

Step 5 - Attach tubing to the coupling.

ATTACH BLACK TUBING TO BLUE FITTING, CLEAR TUBING TO GREEN FITTING AND SECURE WITH TUBING CLAMPS

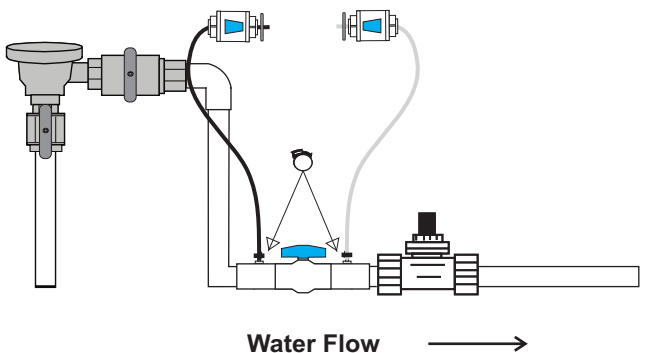

Connect Cap to Irrigation System

Step 6

Turn shut off valves to the off position (shown)

Turn water on at back flow preventer

Connect blue connector to water **IN** connection by pressing the black tubing into the blue fitting

Connect green connector to fertilizer **OUT** connection by pressing the clear tubing into the blue fitting

*Refer to page 3 for detailed tubing operation

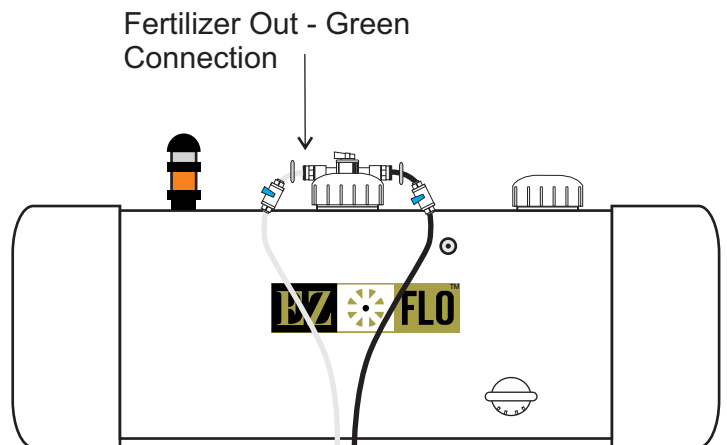
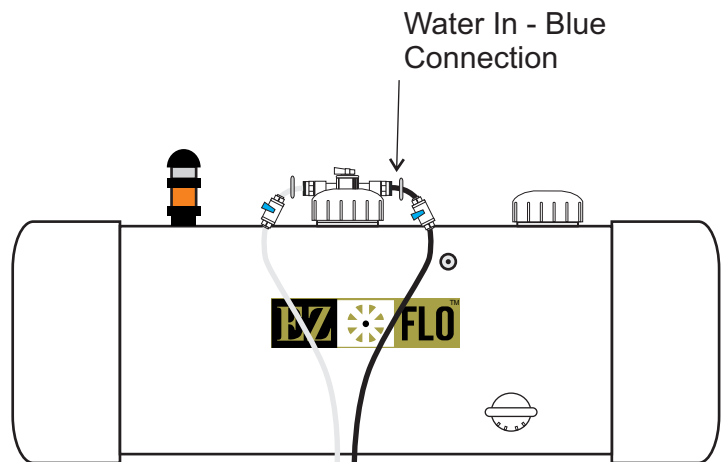
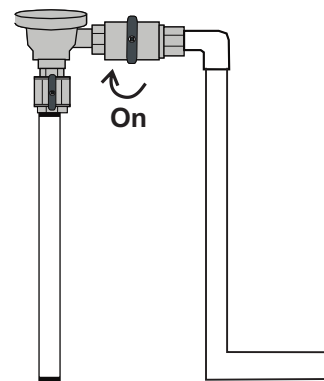
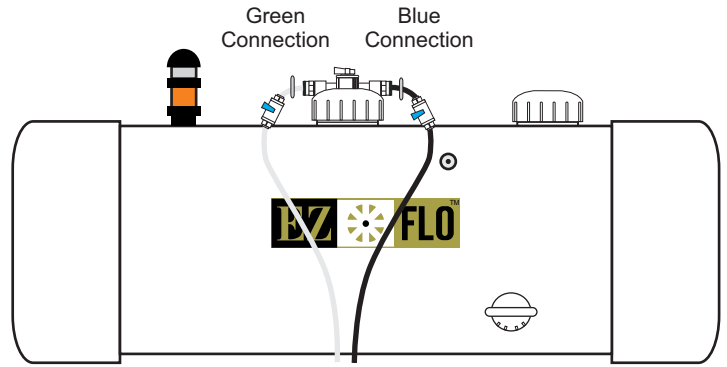

Fill Tank with Product

Step 7 - The EZ-FLO system can be filled with any liquid or water soluble product. EZ-FLO MAXX-PRODUCTS are specifically designed for use with fertigation and all irrigation systems.

Fill the tank based on the product's coverage recommendations or capacity.

Typical fertilizer coverage rate:

- Liquid- 1 Gallon per 10,000 sqft every 4 to 8 weeks
- Powder- 1 Pound per 1,000 sqft every 4 to 8 weeks

Remove fill cap and pour fertilizer directly into tank through the opening and then top off with water until all air is gone from the tank. If your fertilizer is not colored, add blue or green dye.

Model	Tank Size	Maximum Capacity
EZ010-HC	10.0 Gallon	75 lbs dry or 10.0 gal liquid
EZ017-HC	17.5 Gallon	150 lbs dry or 17.5 gal liquid
EZ025-HC	23.0 Gallon	225 lbs dry or 23.0 gal liquid

* ALL TANK CAPACITIES ARE APPROXIMATE *

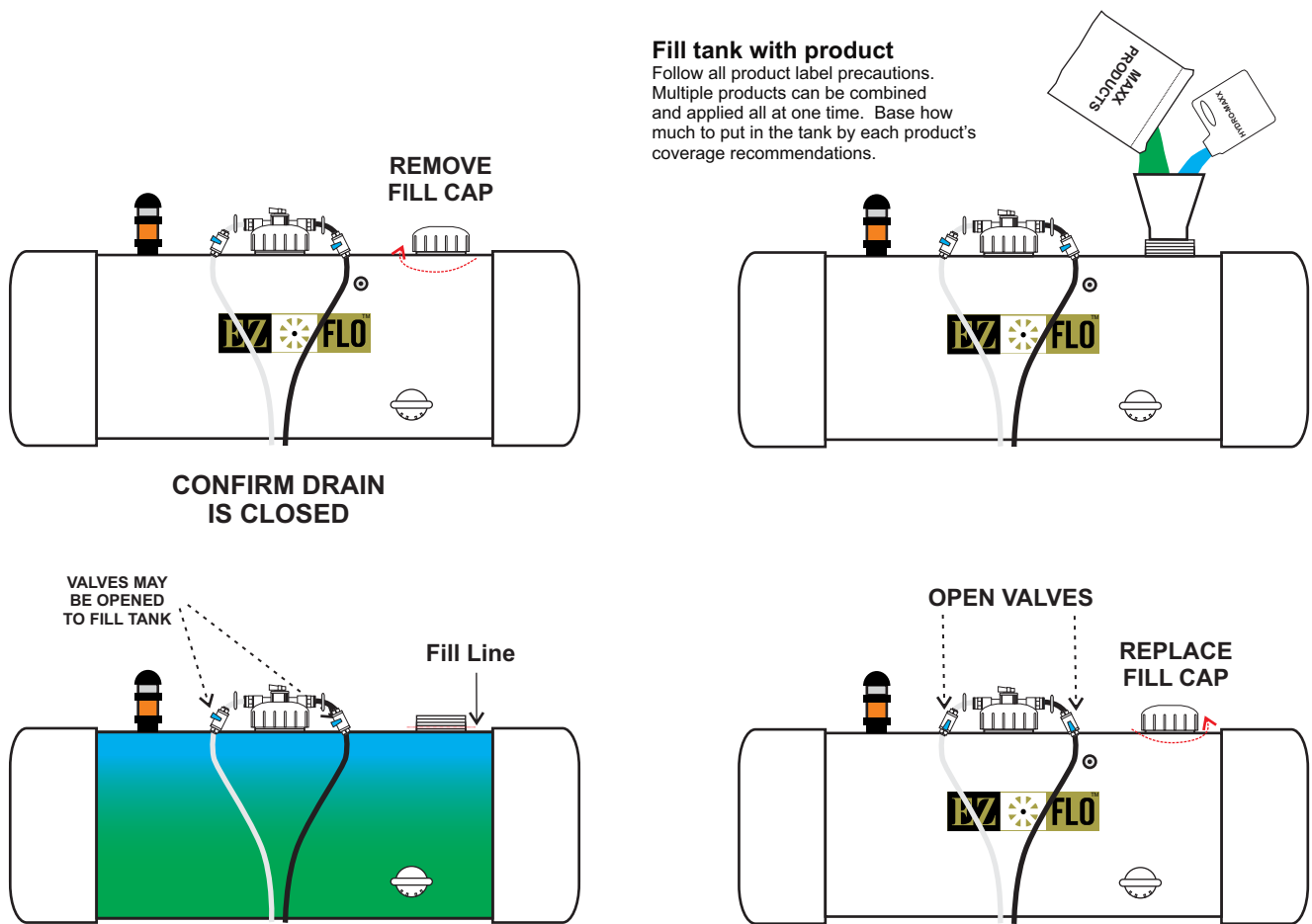

DO NOT LEAVE AIR IN THE TANK

Air will fracture the tank and is not covered by the warranty. Check that the o-ring is in place prior to replacing fill cap.

Connector Calibration - Coupling Ball Valve

The CBV connection must be calibrated to the flow rate of your irrigation system. If the irrigation system is higher flow, primarily composed of spray heads or larger drip irrigation zones, adjustment to the CBV may not be required.

The EZ-FLO system must be full of fertilizer which provides a color that can be used to indicate flow through the clear line. If your fertilizer is not colored, add blue or green dye to the tank.

Start by setting the proportioning cap adjustment setting to the **fast position** and the **CBV in full open position**.

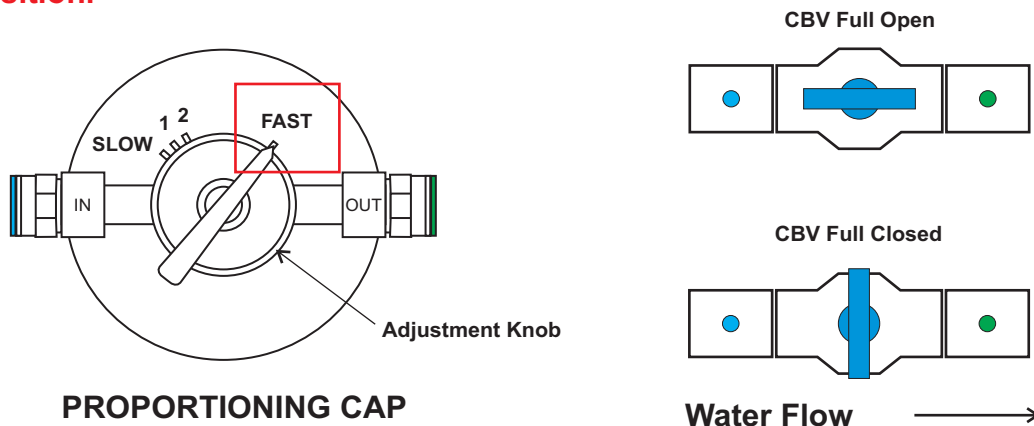

Step 9 - Turn on a sprinkler or drip zone with the closest to average gallons per minute flow rate and watch the clear, fertilizer-out tubing for color.

If color is steadily flowing through the clear output tube, the CBV does not require adjustment. Please note the color in the tube will be lighter than the color in the tank due to the mixing.

If color is not flowing through the clear tubing, slowly turn the CBV to the closed position in small increments, stopping once color begins to flow.

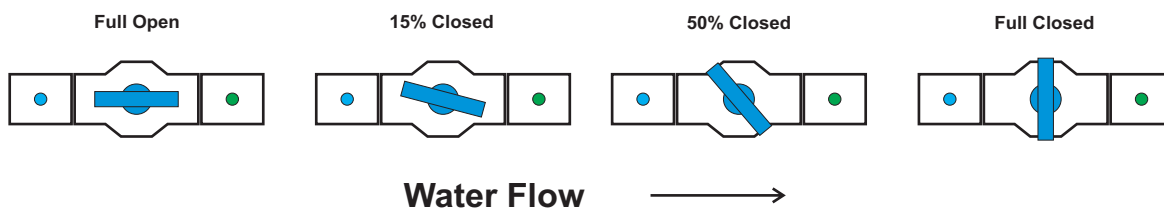

Once color is visible, you no longer have to adjust the CBV connection. You may leave it in position permanently.

To prove the system is working, adjust the feed setting on the cap, back and forth. While the irrigation system is running, turn the knob from slow to fast, and fast to slow. Each time you adjust the knob to a new setting, the color in the tube will change. Slower settings are lighter and faster setting are darker.

Once all is confirmed, leave the handle in the calibrated position, and set the proportioning cap feed rate to the desired setting per your systems instructions.

For additional information, please read the **FAQ/ Troubleshooting** in the CBV instruction manual.

Set Flow Adjustment

Step 10 - Set the flow rate by turning the adjustment knob to the proper setting.

Slow Setting - is used for normal and most common setting in regions with high watering requirements such as hot dry climates or sandy soils.

#1 Setting - is used for normal maintenance in regions with more moderate climates and moderate watering schedules where soils have good moisture retention.

#2 Setting - is used to encourage fast growth or to quickly improve the condition of a landscape in poor condition. The unit will empty more quickly and can be refilled more often.

Fast Setting - is used to for periodic fertilization. The unit will empty more quickly and can be refilled more often.

Setting	*Ratio	OZ. of fertilizer per gal. of water	Based on Watering Frequency*
Slow	15000:1	.008 (1/20 tsp)	4+ days per week
# 1	8000:1	.017 (1/10 tsp)	3 days per week
# 2	2000:1	.064 (2/5 tsp)	2 days per week
Fast	400:1	.320 (2 tsp)	1 day per week

PROPORTIONING CAP

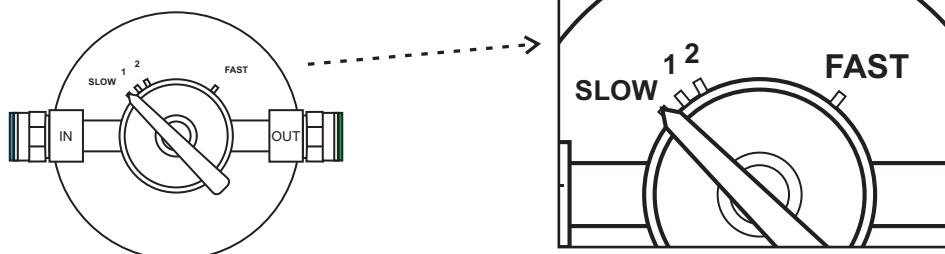

*Ratio refers to the amount of water mixed with the fertilizer. For example, a 400:1 ratio means 400 gallons of water will be mixed with 1 gallon of fertilizer. The adjustment knob can be set in between settings if desired. ***These ratios are approximate because feed rates can vary by the type of product being distributed. Ratios are provided as a general guideline only.*** The watering frequency guideline is general and for convenience only. Additional caution and care should be taken when using a feed setting faster than #1.

Gallons of Water Until Empty

The following table shows the approximate gallons of water required to distribute the fertilizer from the EZ-FLO system at the various flow settings.

Model	EZ001-CX	EZ003-CX	EZ005-FX	EZ010-FX
Slow	22,500	37,500	67,500	127,500
# 1	12,000	20,000	36,000	68,000
# 2	3,000	5,000	9,000	17,500
Fast	600	1,000	1,800	3,400

More detailed application instructions are available on our website:
www.ezfloinjection.com

FAQ

How much product to put into the tank: Refer to the product label and tank capacity from page 6. Additional information is on our website.

What fertilizer can I use: Almost any liquid or water soluble powder product. Do not use dry broadcast fertilizers.

Can I use weed killer/ herbicide in the system: Typically no, hazardous products are not recommended for use in the EZ-FLO system.

What cap setting should I use: Slow and #1 are the most common cap settings. Page 9 offers more details on each setting.

How often do I need to refill: This will vary on landscape size and watering schedule but typically every 4 to 8 weeks.

How do I know when to refill: The system can be checked for color by in the clear output tubing during irrigation operation. If the fertilizer color is gone, you need to refill the system. Alternatively, you may let the system run without fertilizer (just water) and refill based on a set schedule.

How do I know it is working: When the irrigation system is running watch the clear output tube for color. You may adjust the cap from slow to fast to see the color change. You can use blue or green food dye to add color to the fertilizer.

Will I over fertilize: No, the EZ-FLO injection process micro doses products but we do recommend caution when using new products and faster feed settings.

Will the system clog drip irrigation: No. EZ-FLO and Maxx-Products can help clean drip systems and make them work effectively.

If product is mixed with water, will it dilute: No, the patented process and agitation valve control dilution of compatible products.

Will the fertilizer stain: Not if using EZ-FLO recommended products. Check other manufacturers labels if not using EZ-FLO brands.

How do I winterize the system: Simply close the shut off valves, disconnect it from the irrigation system and drain the tank.

The system did not inject any fertilizer: Refer to the "Connector Calibration" and set the CBV to a further closed position.

The system is emptying too fast: Confirm you used the correct cap setting and check the "Connector Calibration" page and adjust the CBV to a more open position.

My system is always full of water, is it working: Yes! This is part of our patent and you can review the videos on our website to see how it works.

Troubleshooting:

I cannot see color when closing the ball valve:

Confirm you have set the knob to fast.

Check to see that both shut off valves on the tubing are open.

Confirm you have a zone of irrigation running (water flowing).

Confirm you have added enough fertilizer and that it has a color.

**For more information
and videos**



Agitation Valve Operation

(Optional)

When using fully concentrated water soluble powders, it is recommended to have the Agitation Valve **ON**.

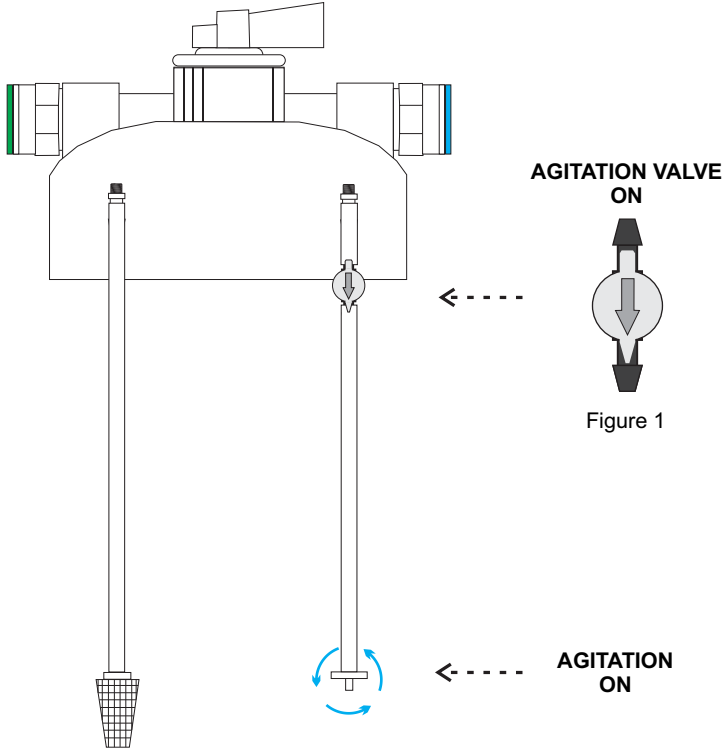

In the **ON** position, the agitation continues to stir and dissolve concentrated product at the bottom.

Significant dilution of the solution does not occur until the powder has fully dissolved.

If only liquid is used, a slow steady dilution can occur at faster feed rates.

The **ON** position is illustrated by the image in figure 1.

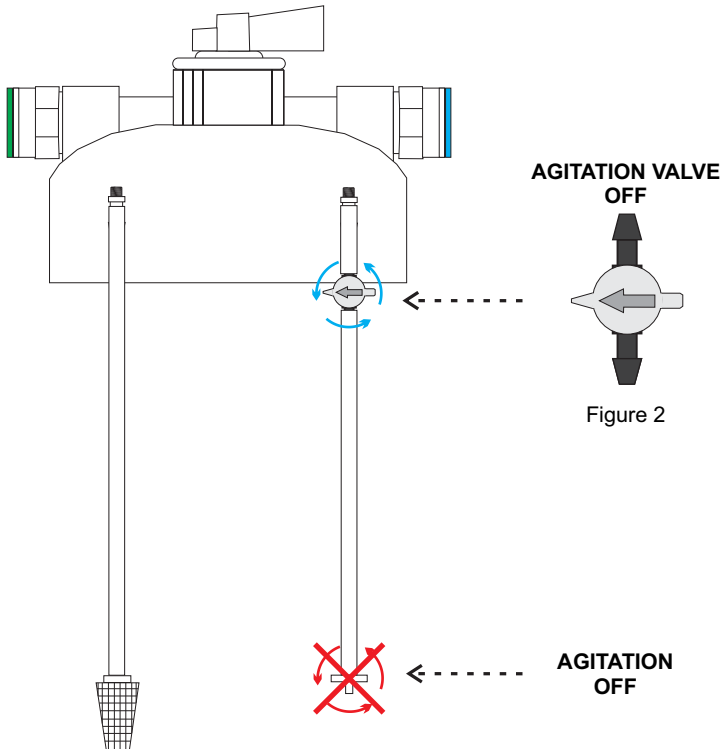

When using fully concentrated liquid, diluted liquid, or dissolved powder products, it is recommended to have the Agitation Valve **OFF**.

In the **OFF** position, the agitation no longer mixes at the bottom.

Significant dilution of the solution does not occur*

The **OFF** position is illustrated by the image in figure 2.

*EZ-FLO tested the Agitation Valve with standard mineral fertilizers, micro nutrients, and acids. Observed variations are +/- 5%. Some products, primarily organic supplements, and humic acids, will leave residue and cloud the solution even when dispensed accurately.

How it works



Quick Refill Guide

Step 1 - Turn off the water using the Shut Off Valves, both valves must be closed

On Position

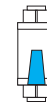

Off Position

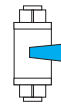

Step 2 - Open drain plug & remove fill cap

CAUTION: the system is under pressure, open slowly to allow for the pressure to safely vent

Grab the tab/handle on the drain plug and turn to the left

There is no need to completely remove the plug, the side ports will drain the fluid.

Some products may leave a slight residual. This may be left in the tank or flushed out.

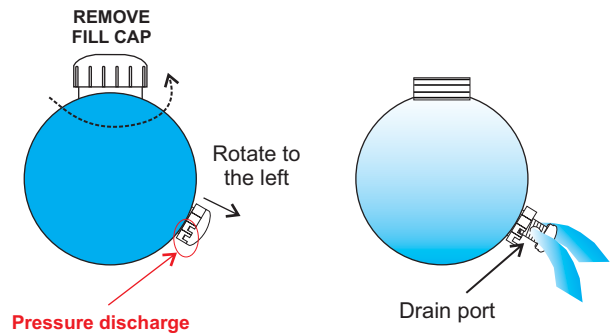

Step 3 - Fill tank with product

Reference fill section for maximum capacities.

Results depend on product quality, use **MAXX-PRODUCTS** for best performance

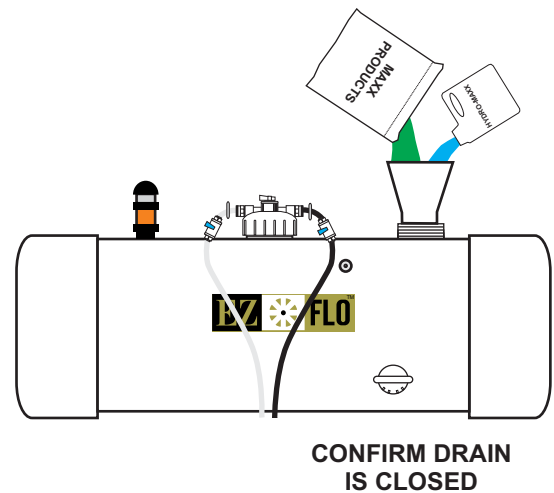

Step 4 - Fill tank with water by opening Shut Off Valve or hose until full

DO NOT LEAVE AIR IN THE TANK

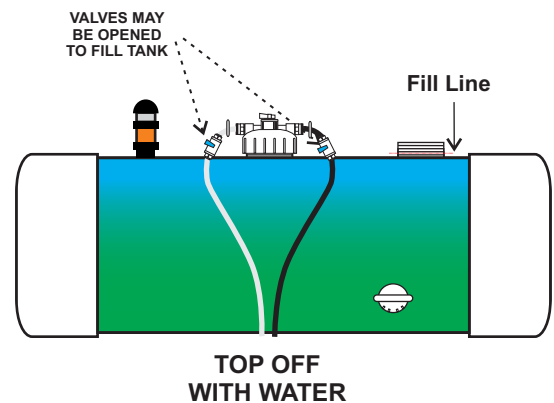

Step 5 - Screw on fill cap & turn on both Shut Off Valves

*Check to make sure o-ring is in place under the cap prior to screwing the cap back on.

